

Hydro-Rain®'s new professional line of energy efficient LED Landscape lights provides complete lighting control, straight-forward selection, no-hassle installation, elegant design, and breathtaking accents for homes and plants alike. The brilliant warm light generated by our professional-quality, longlasting lights enriches the natural beauty of any landscape.

The welcoming, warm light generated by Hydro-Rain®'s new LED Landscape Path Lights adds ambiance and security to any landscape. Made with durable, premium materials and a high-quality LED, these path lights promise to give years of balanced lighting and beauty.



HRL-BKP1-LED-3W (06701)



HRL-BRP1-LED-3W (06703)



HRL-BRP2-LED-3W (06702)

SPECIFICATIONS

- Part Numbers: 06701, 06703
- Material: Aluminum
- Finish: Black or Textured Bronze
- Power Usage: 3 Watts
- 12v LED Light
- Mounting Stake Included
- Expected Life: 50,000 hrs
- 5 Year Warranty

Dimensions

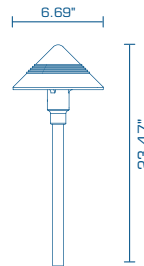

Light Direction

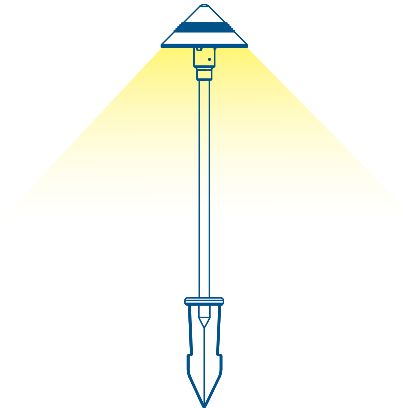

Color Temperature

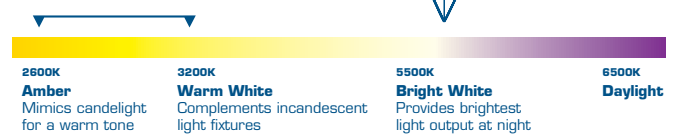

SPECIFICATIONS

- Part Number: 06702
- Material: Aluminum
- Finish: Textured Bronze
- Power Usage: 3 Watts
- 12v LED Light
- Mounting Stake Included
- Expected Life: 50,000 hrs
- 5 Year Warranty

Dimensions

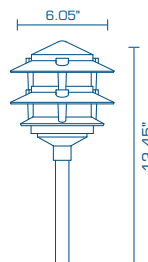

Light Direction

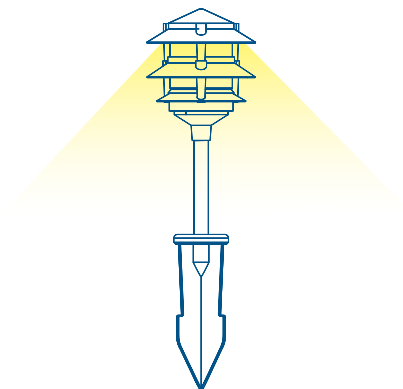

Color Temperature

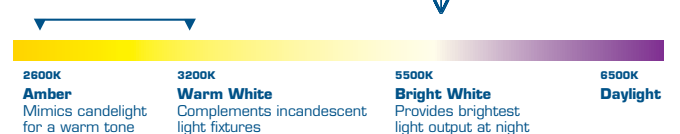

The crisp, clean light illuminating from Hydro-Rain®'s new LED Landscape Spot Lights enriches the beauty and security of any house or landscape. Durable construction and premium materials together with LED efficiency provide years of outstanding performance.



HRL-BKS1-LED-3W (06721)

HRL-BRS1-LED-3W (06723)

SPECIFICATIONS

- Part Numbers: 06721, 06723
- Material: Aluminum
- Finish: Black or Textured Bronze
- Power Usage: 3 Watts
- 12v LED Light
- Mounting Stake Included
- Expected Life: 50,000 hrs
- 5 Year Warranty

Dimensions

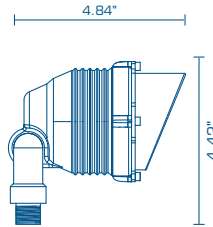

Light Direction

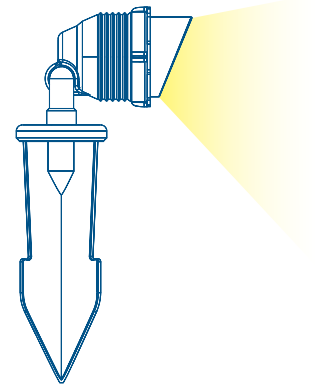

Color Temperature

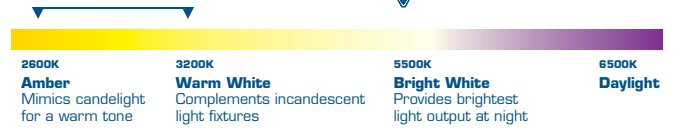

SPECIFICATIONS

- Part Number: 06722
- Material: Aluminum
- Finish: Textured Bronze
- Power Usage: 3 Watts
- 12v LED Light
- Mounting Stake Included
- Expected Life: 50,000 hrs
- 5 Year Warranty

Dimensions

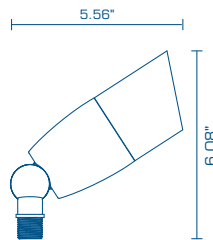

Light Direction

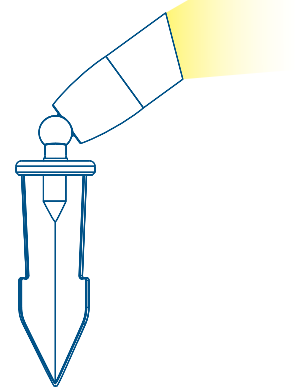

Color Temperature

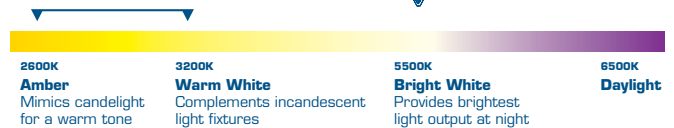

HRL-BRS2-LED-3W (06722)

HydroRain®'s new 3-Station LED Landscape Light Controller/Transformer, with a built in 60 Watt power supply, is ideal for providing the ultimate in control for a landscape lighting system. Three independently, fully programmable stations allow for a landscape to be sectioned off by area, function, or type of light fixture, providing additional security, comfort, and beauty, while maintaining optimal energy savings.

A weather-proof housing and light sensor on an expandable 10 ft. cable facilitate indoor or outdoor mounting. Swing door access and simple screw terminals make it easy for anyone to wire. Take control of any landscape with this new and versatile 3-Station LED Landscape Light Controller/Transformer.

BENEFITS OF INDEPENDENT STATIONS

Multiple stations allow for managing groups of lights independently. For instance, lights can turn on for guests approaching the home in front, without activating the lights in the back of the house. Stations for spot lights can be programmed to turn on at different times than path lights. Lighting stations can also be independently activated by individual motion sensors (sold separately). Setup is easy with HydroRain®'s headache-free programming.

HydroRain®'s stylish Motion Sensor adds increased flexibility to outdoor landscape lighting. Connecting directly into HydroRain®'s 3-Station LED Landscape Light Controller/Transformer, it can be mounted on any wall or hidden in a garden or flowerbed with its stake-mount option. The sensor features an 120° motion detection angle that senses movement up to 40 ft. away.

SPECIFICATIONS

- Part Number: 06700
- 3 Fully Programming Stations
- 6 Independent Start Times
- 60 Watt Built-In Electronic Transformer 12v AC/DC
- Light Sensor with 10 ft. Expandable Cable
- Motion Sensor Capable
- 5 Year Warranty



HRL-100-60W

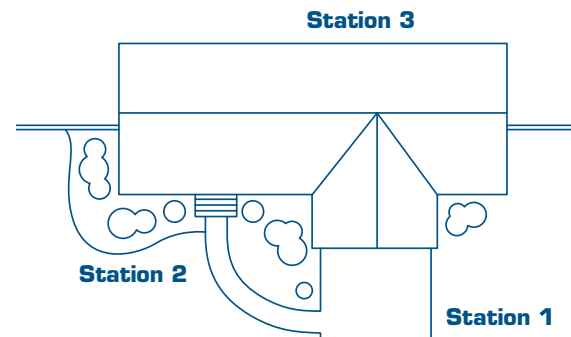

SPECIFICATIONS

- Part Number: 06730
- Angle: 120°
- Range: 40 ft.
- Mounting Stake Included
- 5 Year Warranty

Dimensions

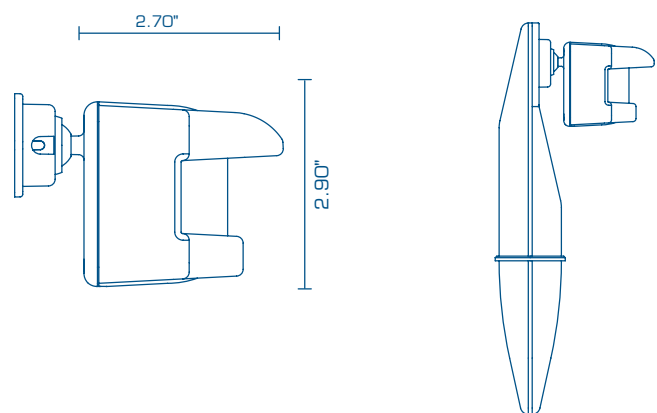

Wall Mount

Stake Mount



HRL-100-MS